

MPM

is a self-motivated learning system personalized for each student. Instead of lecturing to a large class of students with the same level materials, its unique design best fits the special needs of an individual for independent learning.

MPM's Four Main Goals

- To promote problem-solving skills through the development of independent, divergent, and creative thinking.
- To increase self-confidence by continuously challenging the brain with the new and the unknown.
- To encourage an active self-learning attitude through PSL.
- Most importantly, to enjoy and love learning math.

Manipulative Tools

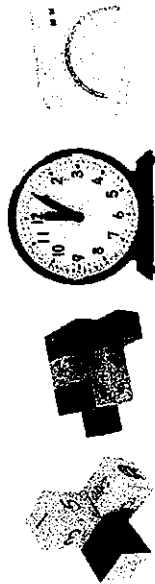

A touch of the future

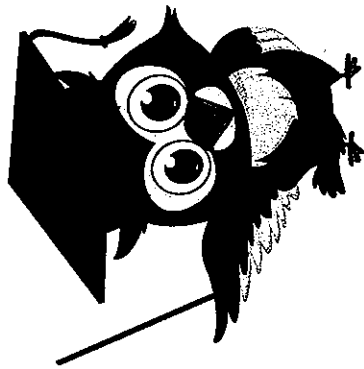

ACT / SAT
AP / SAT Subject
Homework Help
College Counselling

I Learn Education

After School / Academic Classes / Homework Help

Irene Tang
Director

Tel: 510.396.7122
1213 E. Calaveras Blvd.
Milpitas, CA 95035

I Learn AMC 8, 10, & 12

**Practice & Mastery of
the Common Core
State Standards!**

Problem Solving Skills

Independent Learning

Logical Inference

Critical Thinking

REVIEWED AND APPROVED FOR DISTRIBUTION
District of Columbia
products, services, or views contained in the flyer.



For more information and nearby classrooms

Call: 510-396-7122

What is MPM?

MPM is a well-sequenced math program designed around the concepts of Multi-Process and Multi-Model mathematics for K-6 grade students.

Through the Personalized System of Learning, students optimize their learning independently with minimal guidance from the instructor. MPM makes a student think and not just memorize the math facts like other programs.

By using MPM's specially designed manipulative tools, student not only understand the concept but also build a strong math foundation. Importantly, they know how to apply what they learn in real life.

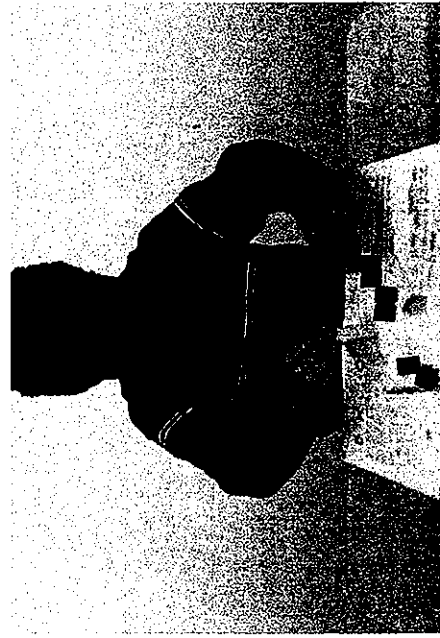

Sample Problem for 1st grade

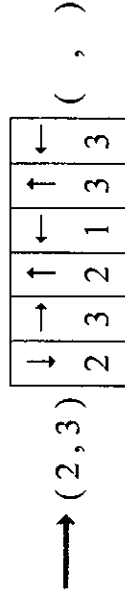
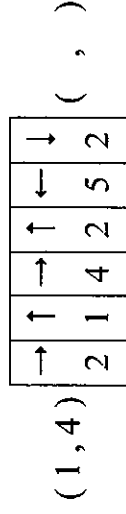
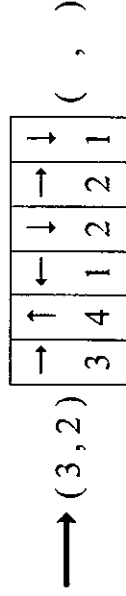
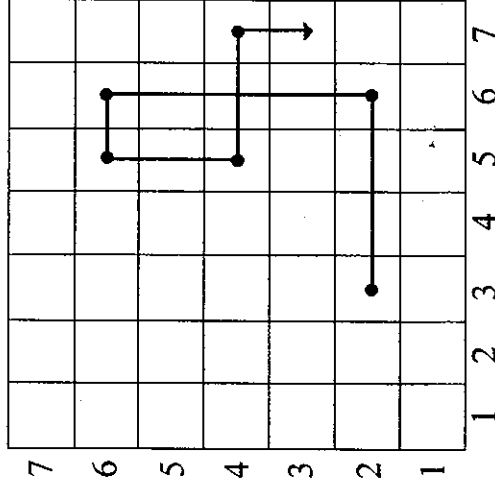

Sample Problem for 3rd grade

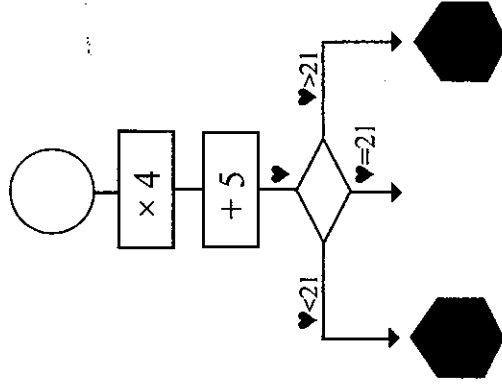
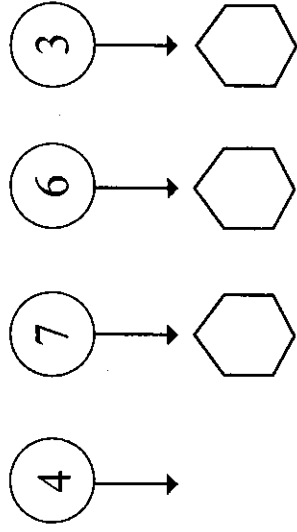

MPM uses its unique and interesting design to train students in computation.

